

Garden life performer



VERTAK

NINGBO VERTAK MECHANICAL&ELECTRONIC CO., LTD

ADD:#288, Guangming Road, Zhuang Shi, Zhenhai District, Ningbo, China (315201)
TEL: +86-574-55877699 FAX: 86-576-82720226
E-MAIL:sale@vertak.com [Https://www.vertak.com](https://www.vertak.com)

Garden Pruning Tools

Garden life performer



*The
Gardener's
Friend*

VERTAK

*Pruning is an important job in the garden
- it helps to keep plants in shape, encourages
the production of fruit and flowers and can help
to prevent disease.*



Must-have Pruning Tools For Gardeners

Pruning is an important job in the garden - it helps to keep plants in shape, encourages the production of fruit and flowers and can help to prevent disease. So it's worth getting well kitted out with pruning tools. Having the right pruning tool for your tasks will make gardening easier and keep your garden healthier and better-looking.

Start with a high-quality, well-made cutting tool and keep it sharp and rust-free - clean cuts ensure your plants recover quickly and look better than ever. So what are the pruning tools every gardener needs in the shed? **Here's our list!**

PRODUCT DESCRIPTION

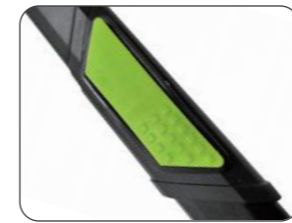

TELESCOPIC BUTTON



NON-SLIP
COMFORTABLE HANDLE

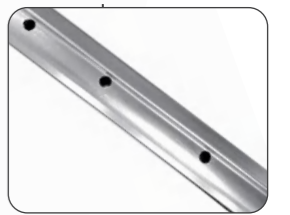

COMBINATION HANDLE OF
STEEL & ALUMINIUM

HIGH CARBON STEEL BLADES

The non-stick coating reduces friction & protects against rust for long lasting use.

ANTI-SLIP BAYONET

LEVER ACTION
POWER SAVING

QUALITY BLADE MADE OF
HIGH CARBON STEEL

TG1206063-A

> 29"-39.5" Lever Action Bypass Lopper

- Carbon steel with non-stick coating blade
- Aluminium telescopic handle with soft grips
- Lever action power saving



SK5
BLADE
Available



Qty/Ctn	Meas	G.W.N.W.
12pcs	76*38*24cm	20.5/20kg

TG1206063-B

> 29"-39.5" Lever Action Anvil Lopper

- Carbon steel with non-stick coating blade
- Aluminium telescopic handle with soft grips
- Lever action power saving

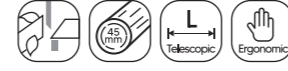

SK5
BLADE
Available



Qty/Ctn	Meas	G.W.N.W.
12pcs	76*38*24cm	21/20.8kg

TG1206062-B

> 32.5" Lever Action Bypass Lopper

- Carbon steel with non-stick coating blade
- Aluminium telescopic handle with soft grips
- Lever action power saving



SK5
BLADE
Available



Size	Qty/Ctn	Meas	G.W.N.W.
83.5cm	12pcs	84.5*36*24cm	18/17kg

TG1206062-A

> 32.5" Anvil Lopper

- Carbon steel with non-stick coating blade
- Aluminium telescopic handle with soft grips
- Lever action power saving



SK5
BLADE
Available



Size	Qty/Ctn	Meas	G.W.N.W.
82.5cm	12pcs	84.5*36*24cm	17/16.5kg

TG1206063-C

> 28"-39.5" Lever Action Bypass Lopper

- Carbon steel with non-stick coating blade
- Aluminium telescopic handle with soft grips
- Lever action power saving



SK5
BLADE
Available



Qty/Ctn	Meas	G.W.N.W.
12pcs	76*38*24cm	20.5/20kg

TG1206063-D

> 29.5"-34.5" Lever Action Hedge Shear

- Carbon steel with non-stick coating blade
- Aluminium telescopic handle with soft grips
- Lever action power saving



SK5
BLADE
Available



Qty/Ctn	Meas	G.W.N.W.
12pcs	77.7*35.5*19.5cm	16.8/15.8kg

TG1206062-C

> 32" Lever Action Bypass Lopper

- Carbon steel with non-stick coating blade
- Aluminium telescopic handle with soft grips
- Lever action power saving



SK5
BLADE
Available



Size	Qty/Ctn	Meas	G.W.N.W.
81.5cm	12pcs	83.5*36*24cm	14/13kg

TG1206062-D

> 26.5" Lever Action Hedge Shear

- Carbon steel with non-stick coating blade
- Aluminium telescopic handle with soft grips
- Lever action power saving



SK5
BLADE
Available



Size	Qty/Ctn	Meas	G.W.N.W.
68cm	12pcs	70.5*37*19.5cm	13/12kg

PRODUCT DESCRIPTION



HIGH CARBON STEEL BLADES

The non-stick coating reduces friction & protects against rust for long lasting use.

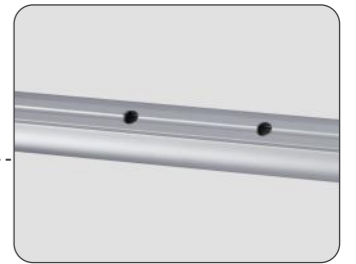

COMBINATION HANDLE OF STEEL & ALUMINIUM

Combination handle of high quality steel & aluminium makes it robust and durable, also lightweight and portable.



NON-SLIP COMFORTABLE HANDLE

Increase cutting force and hand friction, which can make cutting more labor-saving.



TELESCOPIC BUTTON

Extendable arms makes pruning not limited by the height of branches.

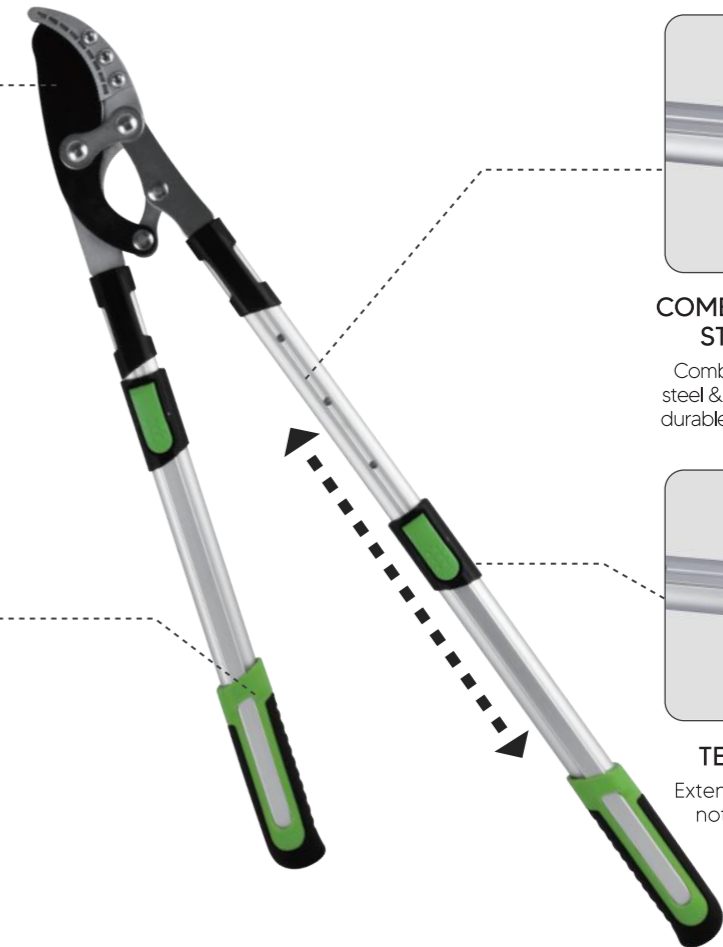

SPEED CUT - FAST AND VERSATILE

Small opening angle for comfortable working even in narrow places - and to cut thinner branches quickly one after the other.

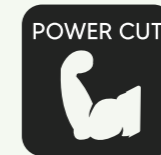

POWER CUT -STRONG AND COMFORTABLE

Larger opening angle activates Power Cut mode for powerful work. Even thick knots up to 50 mm are cut "soft as butter" - the larger spreading angle and resulting greater leverage make it possible.



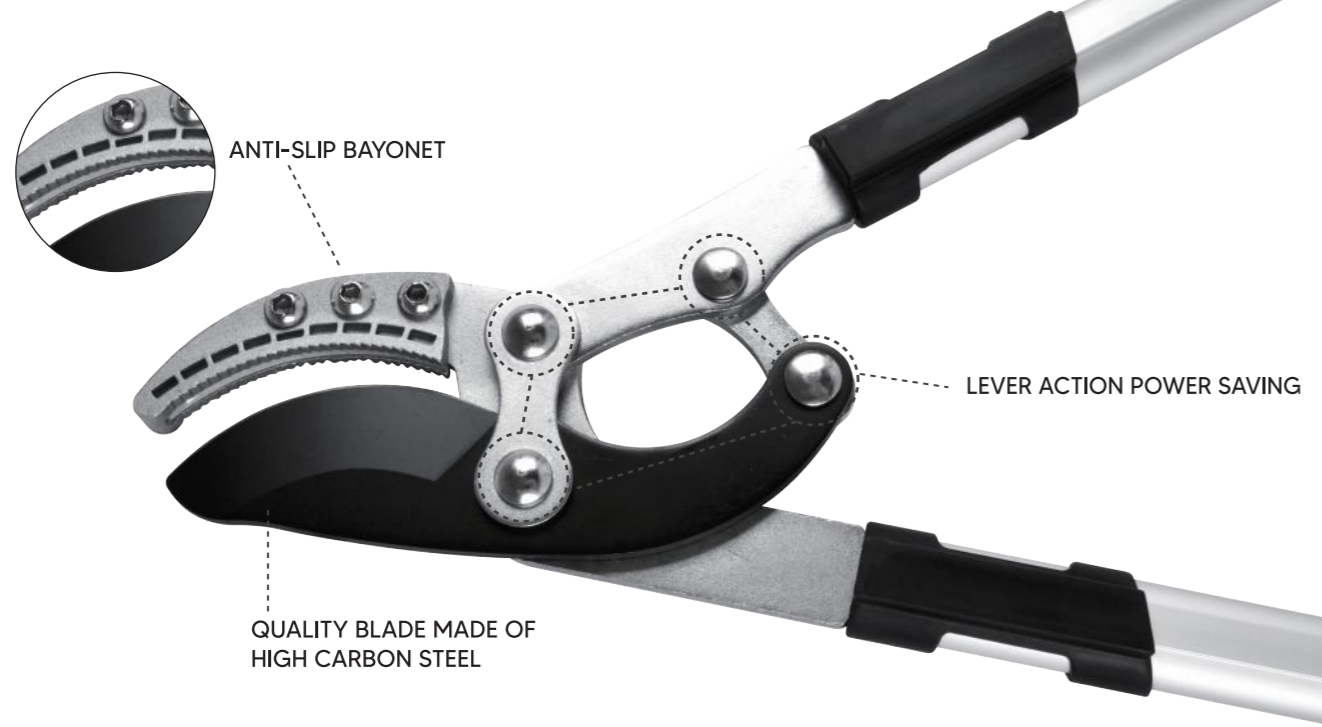

TG1206052-G

> Lever Action Anvil Lopper

- Carbon steel with non-stick coating blade
- Aluminium telescopic handle with soft grips
- Lever action power saving



SK5 BLADE Available



Qty/Ctn	Meas	G.W.N.W.
6pcs	74*44*13.5cm	10/9.2kg

TG1206051-F

> Lever Action Anvil Lopper

- Carbon steel with non-stick coating blade
- Aluminium handle with soft grips
- Lever action power saving



SK5 BLADE Available



Size	Qty/Ctn	Meas	G.W.N.W.
76.5cm	6pcs	78.5*35*11.5cm	9/8.43kg

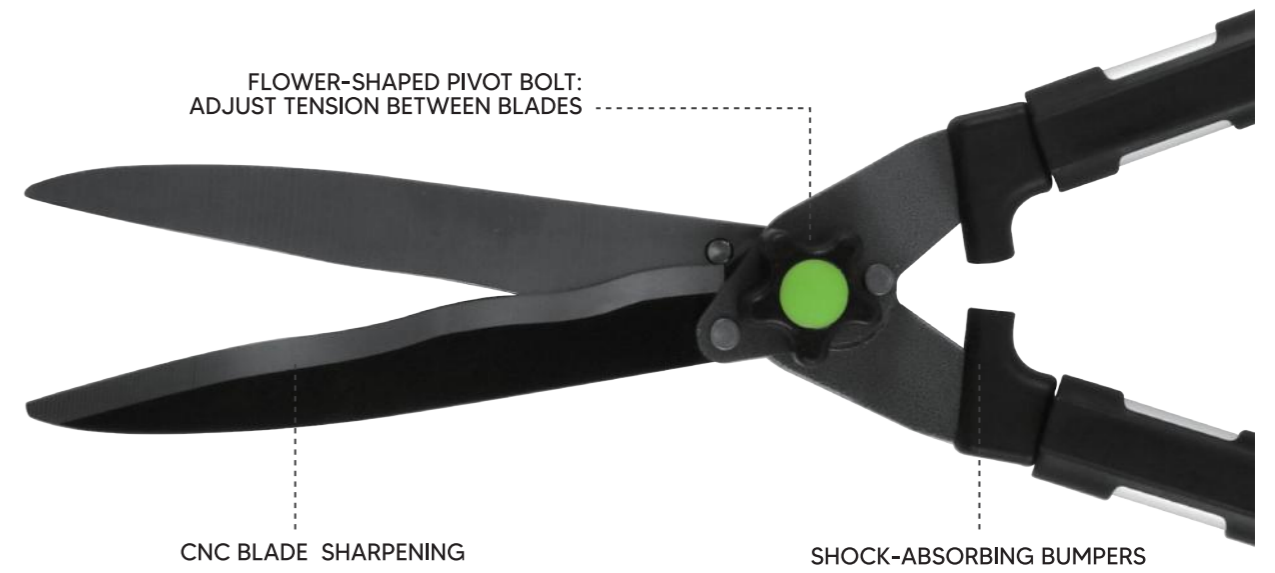

TG1206052-H

> Hedge shear

- Carbon steel with non-stick coating blade
- Aluminium telescopic handle with soft grips

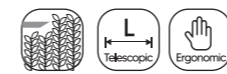

SK5 BLADE Available



Qty/Ctn	Meas	G.W.N.W.
6pcs	73*31.5*13.5cm	8.2/7.6kg

TG1206051-A

> Hedge shear

- Carbon steel with non-stick coating blade
- Aluminium handle with soft grips



SK5 BLADE Available



Size	Qty/Ctn	Meas	G.W.N.W.
59cm	6pcs	61*27*14cm	6.2/5.67kg





TG1206052-A

> Ratchet Bypass Lopper

- Carbon steel with non-stick coating blade
- Aluminium telescopic handle with soft grips
- Ratchet structure power saving



SK5
BLADE
Available



Qty/Ctn	Meas	G.W.N.W.
6pcs	72*32*15cm	9.5/8.7kg

TG1206052-E

> Ratchet Anvil Lopper

- Carbon steel with non-stick coating blade
- Aluminium telescopic handle with soft grips
- Ratchet structure power saving



SK5
BLADE
Available



Qty/Ctn	Meas	G.W.N.W.
6pcs	69*36*15cm	9.5/8.7kg

TG1206052-F

> Lever Action Bypass Lopper

- Carbon steel with non-stick coating blade
- Aluminium telescopic handle with soft grips
- Lever action power saving



SK5
BLADE
Available



Qty/Ctn	Meas	G.W.N.W.
6pcs	74*44*13.5cm	9.5*8.7kg

TG1206052-B

> Lever Action Anvil Lopper

- Carbon steel with non-stick coating blade
- Aluminium telescopic handle with soft grips
- Lever action power saving



SK5
BLADE
Available



Qty/Ctn	Meas	G.W.N.W.
6pcs	70*44*13.5cm	9.6/8.8kg

TG1206052-C

> Bypass Lopper

- Carbon steel with non-stick coating blade
- Aluminium telescopic handle with soft grips



SK5
BLADE
Available



Qty/Ctn	Meas	G.W.N.W.
6pcs	69*30*13.5cm	7.6/6.9kg

TG1206052-D

> Bypass Lopper

- Carbon steel with non-stick coating blade
- Aluminium telescopic handle with soft grips



SK5
BLADE
Available



Qty/Ctn	Meas	G.W.N.W.
6pcs	68*42*12cm	8.5/8kg

TG1206052-Y

> Lever Action Bypass Lopper

- Carbon steel with non-stick coating blade
- Aluminium telescopic handle with soft grips
- Lever action power saving



SK5
BLADE
Available



Qty/Ctn	Meas	G.W.N.W.
6pcs	69*44*13.5cm	10/9kg

TG1206052-Q

> Lever Action Bypass Lopper

- Carbon steel with non-stick coating blade
- Aluminium telescopic handle with soft grips
- Lever action power saving



SK5
BLADE
Available



Qty/Ctn	Meas	G.W.N.W.
6pcs	69*34.5*13.5cm	8.2/7.56kg

TG1206052-L

> Lever Action Hedge Shear

- Carbon steel with non-stick coating blade
- Aluminium telescopic handle with soft grips
- Lever action power saving

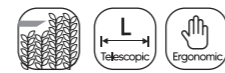

SK5
BLADE
Available



Qty/Ctn	Meas	G.W.N.W.
6pcs	76*26*15cm	8/7.2kg

TG1206052-V

> Hedge Shear

- Carbon steel with non-stick coating blade
- Aluminium telescopic handle with soft grips



SK5
BLADE
Available



Qty/Ctn	Meas	G.W.N.W.
6pcs	72x31.5x16.5cm	7.6/7kg



TG1206051-X

> Lever Action Bypass Lopper

- Carbon steel with non-stick coating blade
- Aluminium handle with soft grips
- Lever action power saving



SK5
BLADE
Available



Size	Qty/Ctn	Meas	G.W.N.W.
75cm	6pcs	81*35*11.5cm	8.8/8.16kg

TG1206051-W

> Ratchet Anvil Lopper

- Carbon steel with non-stick coating blade
- Aluminium handle with soft grips
- Ratchet structure power saving



SK5
BLADE
Available



Size	Qty/Ctn	Meas	G.W.N.W.
75cm	6pcs	77*36.5*11.5cm	8.4/7.8kg

TG1206051-E

> Ratchet Bypass Lopper

- Carbon steel with non-stick coating blade
- Aluminium handle with soft grips
- Ratchet structure power saving



SK5
BLADE
Available



Size	Qty/Ctn	Meas	G.W.N.W.
75cm	6pcs	77*35*14cm	8.5/7.8kg

TG1206051-R

> Bypass Lopper

- Carbon steel with non-stick coating blade
- Aluminium handle with soft grips



SK5
BLADE
Available



Size	Qty/Ctn	Meas	G.W.N.W.
73cm	6pcs	75*35*14cm	7.8/7kg

TG1206051-B

> Lever Action Bypass Lopper

- Carbon steel with non-stick coating blade
- Aluminium handle with soft grips
- Lever action power saving



NON-STICK COATING
SK5 BLADE Available



Size	Qty/Ctn	Meas	G.W.N.W.
74cm	6pcs	76*35*11.5cm	8.5/7.7kg

TG1206051-J

> Lever Action Bypass Lopper

- Carbon steel with non-stick coating blade
- Aluminium handle with soft grips
- Lever action power saving



NON-STICK COATING
SK5 BLADE Available



Size	Qty/Ctn	Meas	G.W.N.W.
74cm	6pcs	76*34.5*11.5cm	7/6.5kg

TG1206051-D

> Lever Action Anvil Lopper

- Carbon steel with non-stick coating blade
- Aluminium handle with soft grips
- Lever action power saving



NON-STICK COATING
SK5 BLADE Available



Size	Qty/Ctn	Meas	G.W.N.W.
74cm	6pcs	76*35*11.5cm	8.6/7.9kg

TG1206051-H

> Lever Action Hedge Shear

- Carbon steel with non-stick coating blade
- Aluminium handle with soft grips



NON-STICK COATING
SK5 BLADE Available



Size	Qty/Ctn	Meas	G.W.N.W.
68cm	6pcs	70*30*13cm	6.5/5.9kg



TG1206051-N

> Bypass Lopper

- Carbon steel with non-stick coating blade
- Aluminium handle with soft grips



NON-STICK COATING
SK5 BLADE Available



Size	Qty/Ctn	Meas	G.W.N.W.
72cm	6pcs	74*34.5*11.5cm	6.4/5.82kg

TG1206051-I

> Hedge Shear

- Carbon steel with non-stick coating blade
- Aluminium handle with soft grips



NON-STICK COATING
SK5 BLADE Available

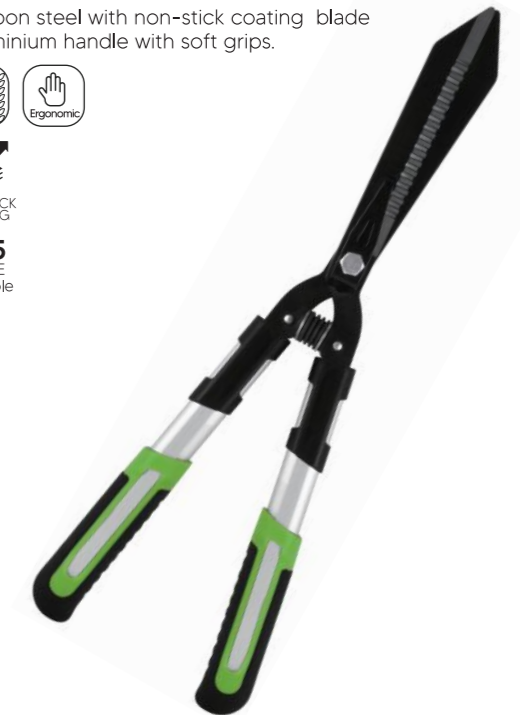

Size	Qty/Ctn	Meas	G.W.N.W.
58cm	6pcs	760*24*12.5cm	6/5.46kg

PRODUCT DESCRIPTION



BYPASS BLADE DESIGN

Provides clean cuts on stems and small branches up to 5/8 inch thick.



ERGONOMIC DESIGNED HANDLES

The pruning loppers specially designed handle is ergonomically.



COMBINATION HANDLE OF STEEL & ALUMINIUM

Combination handle of high quality steel & aluminium makes it robust and durable, also lightweight and portable.

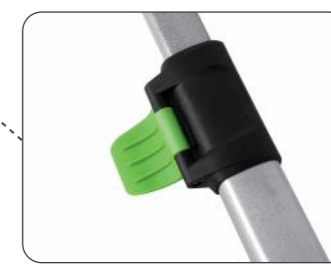

TELESCOPIC BUTTON

Extendable arms makes pruning not limited by the height of branches.

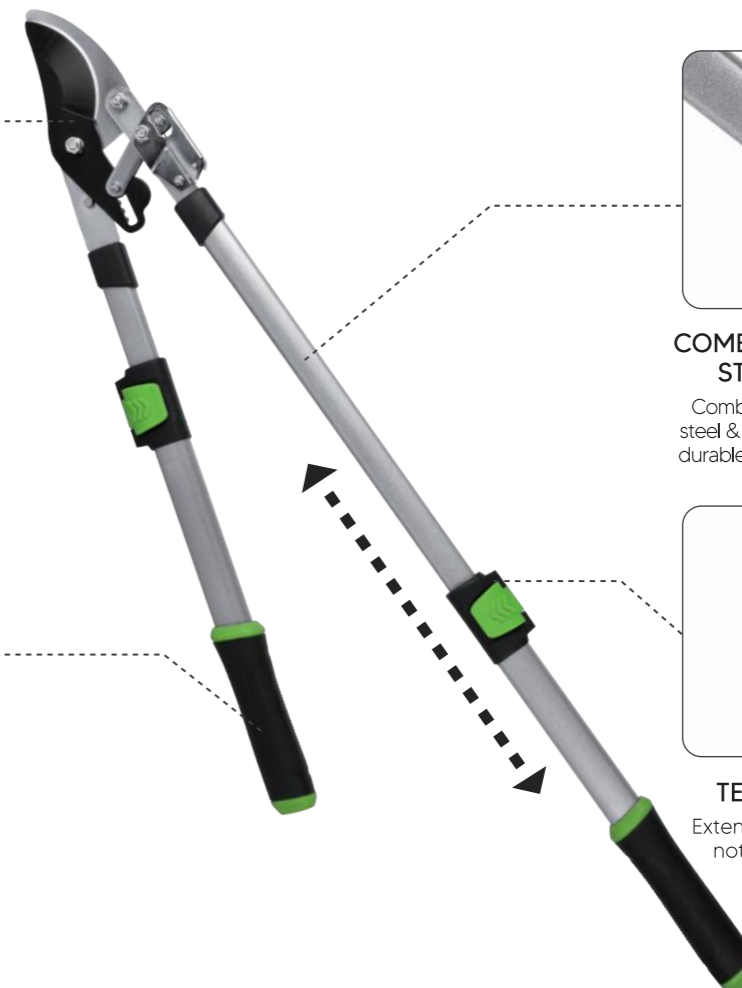

UPPER BLADE NON-STICK COATING
LOWER BLADE CHROME PLATED



CUTTING HEAD WITH MAXIMUM
OPENING ANGLE OF 90 DEGREES

RATCHETED CUTTING MODE

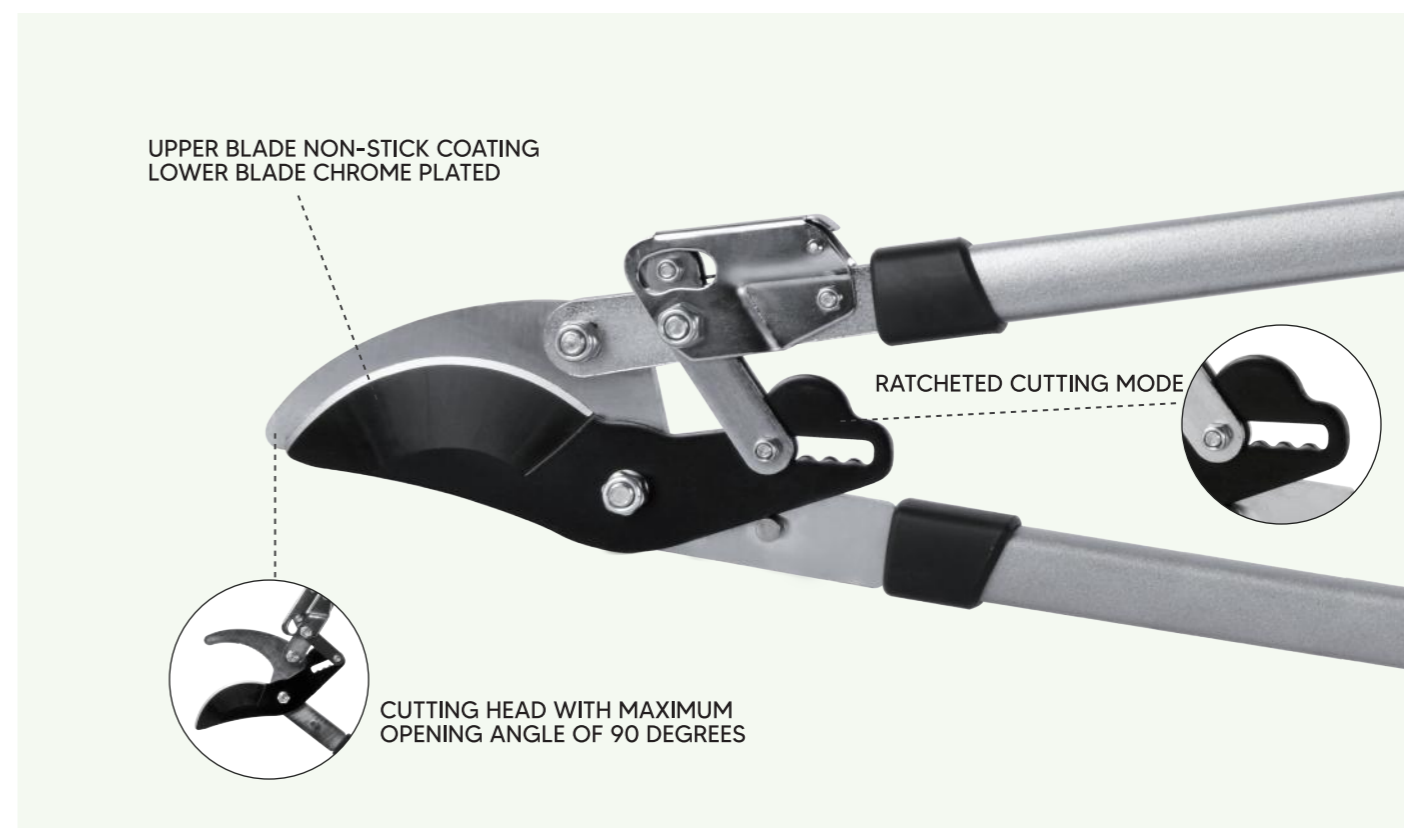

TG1206048-D

> Ratchet Bypass Lopper

- Carbon steel with non-stick coating blade
- Aluminium telescopic handle with soft grips
- Ratchet structure power saving

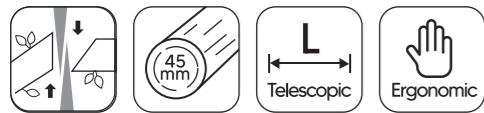

Qty/Ctn	6pcs
Meas	72*46*7cm
G.W.N.W.	12.5/11.5kg



TG1206048-H

> Hedge Shear

- Carbon steel with non-stick coating blade
- Aluminium telescopic handle with soft grips



Qty/Ctn	6pcs
Meas	73*36*14cm
G.W.N.W.	8.5/7.56kg



TG1206048-B

> Lever Action Bypass Lopper

- Carbon steel with non-stick coating blade
- Aluminium telescopic handle with soft grips
- Lever action power saving



Qty/Ctn	6pcs	Meas	72*46*7cm	G.W.N.W.	12/11kg
---------	------	------	-----------	----------	---------



TG1206048-F

> Ratchet Anvil Lopper

- Carbon steel with non-stick coating blade
- Aluminium telescopic handle with soft grips
- Ratchet structure power saving



Qty/Ctn	6pcs	Meas	70*46*7cm	G.W.N.W.	12/11kg
---------	------	------	-----------	----------	---------



TG1206048-C

> Lever Action Anvil Lopper

- Carbon steel with non-stick coating blade
- Aluminium telescopic handle with soft grips
- Lever action power saving



Qty/Ctn	6pcs	Meas	72*46*7cm	G.W.N.W.	12/11kg
---------	------	------	-----------	----------	---------



TG1206048-A

> Bypass Lopper

- Carbon steel with non-stick coating blade
- Aluminium telescopic handle with soft grips



Qty/Ctn	6pcs	Meas	67*40*7cm	G.W.N.W.	11/10kg
---------	------	------	-----------	----------	---------





PRODUCT DESCRIPTION



TENSION ADJUSTER

Hedge shears have a simple knob can adjust the tension of the cut and blade according to the type of hedge.



NON-SLIP COMFORTABLE HANDLE

Increase cutting force and hand friction, which can make cutting more labor-saving.



COMBINATION HANDLE OF STEEL & ALUMINIUM

Combination handle of high quality steel & aluminium makes it robust and durable, also lightweight and portable.



TELESCOPIC BUTTON

Extendable arms makes pruning not limited by the height of branches.



SHARP BLADE DESIGN

the middle section of the blade has small serrations, which can be easily cut and beautify the overall outline of the plant.

TG1206007-P

> Hedge Shear

- Carbon steel with non-stick coating blade
- Aluminium telescopic handle with soft grips

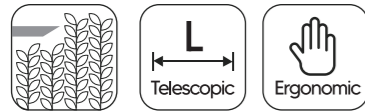

Qty/Ctn	6pcs
Meas	75*31*19cm
G.W.N.W.	9/8kg



TG1206007-B

> Ratchet Anvil Lopper

- Carbon steel with non-stick coating blade
- Aluminium telescopic handle with soft grips
- Ratchet power saving



Qty/Ctn	6pcs
Meas	72*32*20cm
G.W.N.W.	10.3/9.7kg

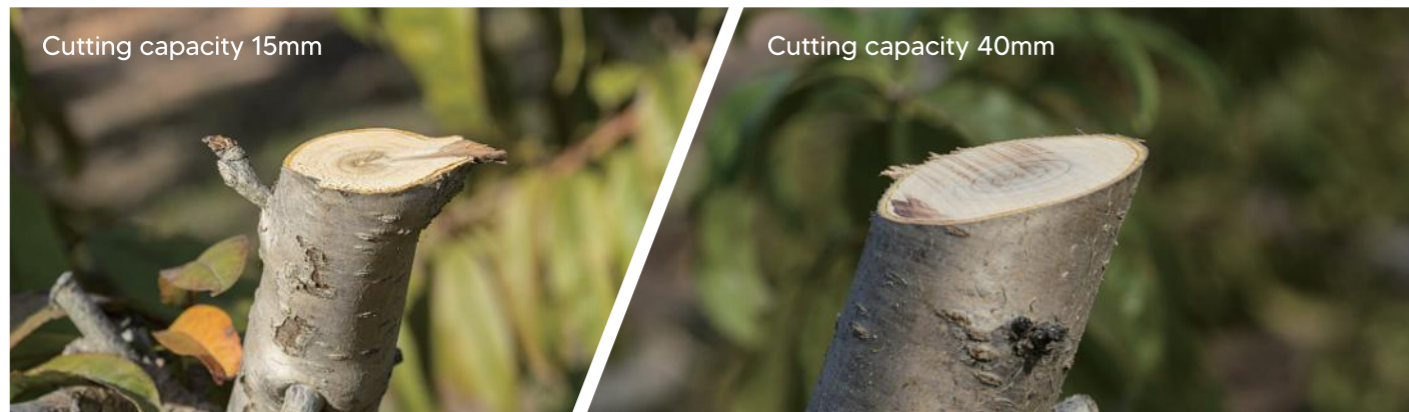

TG1206007-C

> Ratchet Bypass Lopper

- Carbon steel with non-stick coating blade
- Aluminium telescopic handle with soft grips
- Ratchet power saving



Qty/Ctn	Meas	G.W.N.W.
6pcs	72*32*20cm	10.4/9.7kg



TG1206007-F

> Bypass Lopper

- Carbon steel with non-stick coating blade
- Aluminium telescopic handle with soft grips



Qty/Ctn	Meas	G.W.N.W.
6pcs	72*32*20cm	8.5/7.9kg



TG1206007-G

> Lever Action Anvil Lopper

- Carbon steel with non-stick coating blade
- Aluminium telescopic handle with soft grips
- Lever action power saving



Qty/Ctn	Meas	G.W.N.W.
6pcs	72*32*20cm	11/10.2kg



TG1206007-A

> Lever Action Bypass Lopper

- Carbon steel with non-stick coating blade
- Aluminium telescopic handle with soft grips
- Lever action power saving



Qty/Ctn	Meas	G.W.N.W.
6pcs	72*32*20cm	10.6/9.8kg



PRODUCT DESCRIPTION

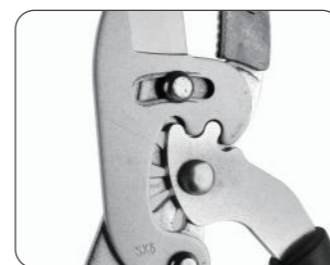

**SK5 CARBON STEEL BLADES
RATCHET ACTION CUTTING**

SK5 carbon steel cutting blade gives lasting sharpness, the compound action blade of this branch cutter has multiple moving parts which multiplies the force applied to the blades 3 times!



**NON-SLIP
COMFORTABLE HANDLE**

Increase cutting force and hand friction, which can make cutting more labor-saving.

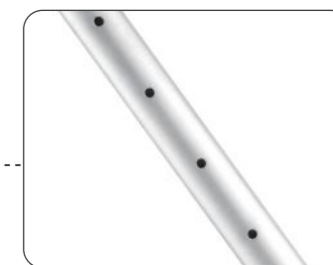

**COMBINATION HANDLE OF
STEEL & ALUMINIUM**

Light yet strong tubular telescopic aluminum handles, soft feel non slip grips for comfort, locking catch for safe storage.



TELESCOPIC BUTTON

Extendable arms makes pruning not limited by the height of branches.

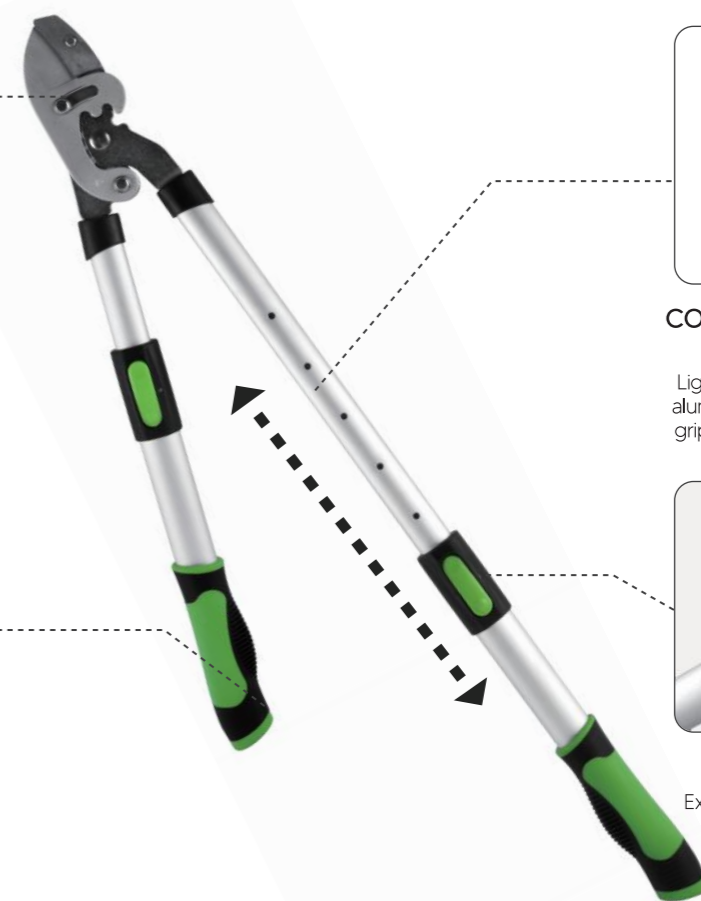

TG1206072-A

> Gear Anvil Lopper

- Carbon steel with non-stick coating blade
- Aluminium telescopic handle with soft grips
- Gear action power saving



SK5
BLADE
Available

Qty/Ctn	6pcs
Meas	66*42*12cm
G.W.N.W.	9.2/8.5kg



TG1206072-B

> Bypass Lopper

- 50 # upper blade non-stick coating lower blade;
- Aluminum tube surface oxidation

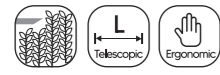

SK5
BLADE
Available



Qty/Ctn	Meas	G.W.N.W.
6pcs	68*38*12cm	8.2/7.5kg



TG1206072-D

> Ratchet Anvil Lopper

- Carbon steel with non-stick coating blade
- Aluminium telescopic handle with soft grips
- Ratchet power saving



SK5
BLADE
Available



Qty/Ctn	Meas	G.W.N.W.
6pcs	68*42*12cm	11/10kg

TG1206072-E

> Lever Action Bypass Lopper

- Carbon steel with non-stick coating blade
- Aluminium telescopic handle with soft grips
- Lever action power saving



SK5
BLADE
Available



Qty/Ctn	Meas	G.W.N.W.
6pcs	68*42*12cm	11/10kg

TG1206072-F

> Lever Action Anvil Lopper

- Carbon steel with non-stick coating blade
- Aluminium telescopic handle with soft grips
- Lever action power saving



SK5
BLADE
Available



Qty/Ctn	Meas	G.W.N.W.
6pcs	69*42*12cm	10.8/9.8kg

TG1206072-C

> Ratchet Bypass Lopper

- Carbon steel with non-stick coating blade
- Aluminium telescopic handle with soft grips
- Ratchet power saving



SK5
BLADE
Available



Qty/Ctn	Meas	G.W.N.W.
6pcs	69*42*12cm	11/10kg



COMBINATION HANDLE

Ergonomically shaped handles for optimum transfer of force with double, sturdy, shaped aluminum handles.

FORGED HIGH CARBON STEEL BLADES

Forging process compacts steel molecules into our strongest, most durable tools that stay sharper longer.

TOUGH AND DURABLE

Drop forged blade finished to a superior hardness and a large notch at the heel of the blade for woody stems.



TG1203079-B

> 28" Forged Bypass Lopper

- High carbon steel, durable
- Steel powder coated handle with soft grip



SK5
BLADE
Available

Size	72cm
Qty/Ctn	6pcs
Meas	78*42*12cm
G.W.N.W.	9/8kg



TG1203079-A

> 30" Forged Bypass Lopper

- High carbon steel, durable
- Steel powder coated handle with soft grip



SK5
BLADE
Available

Size	77cm
Qty/Ctn	6pcs
Meas	78*42*12cm
G.W.N.W.	9/8kg



TG1203079-C

> 26" Forged Hedge shear

- High carbon steel, durable
- Steel powder coated handle with soft grip



SK5
BLADE
Available

Size	65.5cm
Qty/Ctn	6pcs
Meas	67*28*14cm
G.W.N.W.	8/7.3kg



ERGONOMIC DESIGNED HANDLES

The pruning loppers specially designed handle is ergonomic. The handle has a non-slip silicone casing, which makes your handwork more comfortable and has a stronger grip.



NON-SLIP RETRACTABLE BUTTON

The extendable functionality allows you to cut a higher branches than with regular non-extendable handles.



TG1203069-A

> Gear Bypass Lopper

- Carbon steel with non-stick coating blade
- Aluminium telescopic handle with soft grips
- Gear action power saving

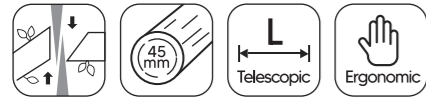

Qty/Ctn	6pcs
Meas	67.5*30*12cm
G.W.N.W.	8.8/8.26kg

TG1203069-B

> Gear Anvil Lopper

- Carbon steel with non-stick coating blade
- Aluminium telescopic handle with soft grips
- Gear action power saving



Qty/Ctn	6pcs
Meas	67.5*30*12cm
G.W.N.W.	8.8/8.26kg

TG1206039-A

> Gear Bypass Lopper

- Carbon steel with non-stick coating blade
- Aluminium handle with soft grips
- Gear action power saving



Size	Qty/Ctn	Meas	G.W.N.W.
75cm	6pcs	77*35*10cm	7.8/6.8kg

TG1206043-B

> Gear Hedge Shear

- Carbon steel with non-stick coating blade
- Aluminium telescopic handle with soft grips
- Gear action power saving



Qty/Ctn	Meas	G.W.N.W.
6pcs	77*27.5*13cm	8/7.2kg

TG1206039-B

> Gear Anvil Lopper

- Carbon steel with non-stick coating blade
- Aluminium handle with soft grips
- Gear action power saving



Size	Qty/Ctn	Meas	G.W.N.W.
75cm	6pcs	77*35*10cm	7.8/6.8kg

TG1206043-A

> Gear Hedge Shear

- Carbon steel with non-stick coating blade
- Aluminium handle with soft grips
- Gear action power saving



Size	Qty/Ctn	Meas	G.W.N.W.
67.5cm	6pcs	70*25*13cm	6.2/5.6kg



TG1203024-N

> Bypass Lopper

- Carbon steel with non-stick coating blade
- Steel telescopic powder coated handle with soft grip



SK5
BLADE
Available



Qty/Ctn	Meas	G.W.N.W.
6pcs	70*38*12cm	10.2/9.4kg

TG1203024-C

> Ratchet Anvil Lopper

- Carbon steel with non-stick coating blade
- Steel telescopic powder coated handle with soft grip



SK5
BLADE
Available



Qty/Ctn	Meas	G.W.N.W.
6pcs	67*30*14.5cm	12/11.3kg

TG1203024-O

> Ratchet Anvil Lopper

- Carbon steel with non-stick coating blade
- Steel telescopic powder coated handle with soft grip
- Ratchet power saving



SK5
BLADE
Available



Qty/Ctn	Meas	G.W.N.W.
6pcs	71x41x12cm	12/11kg

TG1203024-G

> Lever Action Anvil Lopper

- Carbon steel with non-stick coating blade
- Steel telescopic powder coated handle with soft grip
- Lever action power saving



SK5
BLADE
Available



Qty/Ctn	Meas	G.W.N.W.
6pcs	71*41*13.5cm	12.5/11.8kg

TG1203024-F

> Lever Action Bypass Lopper

- Carbon steel with non-stick coating blade
- Steel telescopic powder coated handle with soft grip



SK5
BLADE
Available



Qty/Ctn	Meas	G.W.N.W.
6pcs	71*41*13.5cm	12.3/11.6kg

TG1203024-M

> Hedge Shear

- Carbon steel with non-stick coating blade
- Steel telescopic powder coated handle with soft grip



SK5
BLADE
Available



Qty/Ctn	Meas	G.W.N.W.
6pcs	72*31.5*16.5cm	10.2/9.5kg

TG1203081-B

> 29" Lever Action Anvil Lopper
 -Carbon steel with non-stick coating blade
 -Steel powder coated handle with soft grip



SK5
BLADE
Available



Size	Qty/Ctn	Meas	G.W.N.W.
74.5cm	6pcs	76.5*32*13cm	7.5/7kg

TG1203081-C

> 28.5" Lever Action Bypass Lopper
 -Carbon steel with non-stick coating blade
 -Steel powder coated handle with soft grip



SK5
BLADE
Available



Size	Qty/Ctn	Meas	G.W.N.W.
73cm	6pcs	75*32*13cm	7.5/7kg

TG1203080-B

> 29.5" Ratchet Bypass Lopper
 -Carbon steel with non-stick coating blade
 -Steel powder coated handle with soft grip



SK5
BLADE
Available



Size	Qty/Ctn	Meas	G.W.N.W.
75cm	6pcs	77*32*8cm	8.2/7.2kg

TG1203080-G

> 29" Bypass Lopper
 -Carbon steel with non-stick coating blade
 -Steel powder coated handle with soft grip



SK5
BLADE
Available



Size	Qty/Ctn	Meas	G.W.N.W.
74cm	6pcs	76*37*13cm	8/7.2kg

TG1203081-A

> 28" Bypass Lopper
 -Carbon steel with non-stick coating blade
 -Steel powder coated handle with soft grip



SK5
BLADE
Available



Size	Qty/Ctn	Meas	G.W.N.W.
72cm	6pcs	74*32*13cm	7.5/7kg

TG1203081-D

> 21" Hedge Shear
 -Carbon steel with non-stick coating blade
 -Steel powder coated handle with soft grip

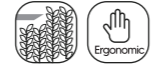

SK5
BLADE
Available



Size	Qty/Ctn	Meas	G.W.N.W.
53.3cm	6pcs	56*28*17cm	6.5/6kg

TG1203080-H

> 30" Lever Action Anvil Lopper
 -Carbon steel with non-stick coating blade
 -Steel powder coated handle with soft grip



SK5
BLADE
Available



Size	Qty/Ctn	Meas	G.W.N.W.
77cm	6pcs	79*42*13cm	10.5/9.6kg

TG1203080-F

> 24" Hedge Shear
 -Carbon steel with non-stick coating blade
 -Steel powder coated handle with soft grip

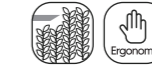

SK5
BLADE
Available



Size	Qty/Ctn	Meas	G.W.N.W.
60cm	6pcs	62*26.5*13.5cm	7.2/6.6kg



TG1201016-A

- > 21" Ratchet Anvil Lopper
- Carbon steel with non-stick coating blade
- Nylon fiber handle with soft grips
- Ratchet power saving



Size	Qty/Ctn	Meas	G.W.N.W.
53.5cm	12pcs	55.5*25*17cm	9.7/9.2kg

TG1201016-B

- > 20.5" Ratchet Anvil Lopper
- Carbon steel with non-stick coating blade
- Nylon fiber handle with soft grips
- Ratchet power saving



Size	Qty/Ctn	Meas	G.W.N.W.
52cm	12pcs	54*25*17cm	9/8.5kg

TG1201015

- > 16.5" Ratchet Anvil Lopper
- Carbon steel with non-stick coating blade
- Nylon fiber handle with soft grips
- Ratchet power saving



Size	Qty/Ctn	Meas	G.W.N.W.
41.9cm	12pcs	45*25*20cm	7.5/7kg

TG1201002

- > 16" Bypass Lopper
- Carbon steel with non-stick coating blade
- Nylon fiber handle with soft grips



Size	Qty/Ctn	Meas	G.W.N.W.
39.5cm	6pcs	45*18*15cm	2.8/2.25kg

TG1208008-B

- > Gear Bypass Lopper
- Carbon steel with non-stick coating blade
- Wooden handle with silica gel grips
- Gear action power saving

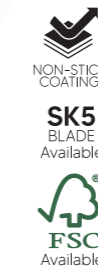

Size	Qty/Ctn	Meas	G.W.N.W.
55cm	6pcs	57*27*12cm	7.2/6.5kg

TG1208008-G

- > Gear Bypass Lopper
- Carbon steel with non-stick coating blade
- Wooden handle with silica gel grips
- Gear action power saving



Size	Qty/Ctn	Meas	G.W.N.W.
75cm	6pcs	78*37*12.5cm	10.5/9.8kg

TG1208008-C

- > Hedge Shear
- Carbon steel with non-stick coating blade
- Wooden handle with silica gel grips

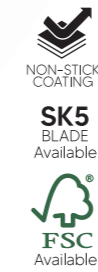

Size	Qty/Ctn	Meas	G.W.N.W.
53cm	12pcs	54*24.5*15cm	11.5/10.5kg

TG1208008-F

- > Gear Bypass Lopper
- Carbon steel with non-stick coating blade
- Wooden handle with silica gel grips
- Gear action power saving

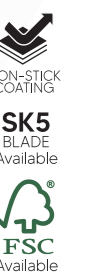

Size	Qty/Ctn	Meas	G.W.N.W.
55cm	6pcs	58*32*13cm	7/6.3kg

TG1208008-H

- > Ratchet Anvil Lopper
- Carbon steel with non-stick coating blade
- Wooden handle with silica gel grips
- Ratchet action power saving



Size	Qty/Ctn	Meas	G.W.N.W.
78cm	6pcs	82*37*13cm	11/10.2kg

TG1208008-I

- > Ratchet Bypass Lopper
- Carbon steel with non-stick coating blade
- Wooden handle with silica gel grips
- Ratchet action power saving



Size	Qty/Ctn	Meas	G.W.N.W.
78cm	6pcs	82*37*13cm	11.2/10.5kg

Everyday Complete Pruning Set



TG1001026

- 8"Rose Pruner
- 21"Hedge Shear
- 24"Lopping Shear



Qty/Ctn	Meas	G.W.N.W.
8pcs	75*28*27cm	16/15kg

TG1001004-E

- 8"Rose Pruner
- 24"Lopping shear
- 2PC garden tool



Qty/Ctn	Meas	G.W.N.W.
8pcs	62*34*20cm	10/9kg

TG1001004-H

- 8"Rose Pruner
- 21"Hedge Shear
- 24"Lopping Shear



Qty/Ctn	Meas	G.W.N.W.
8pcs	66*28*27cm	16/15kg

TG1001036

- 7"Bypass Pruner
- 21"Hedge Shear
- 24"Lopping Shear



Qty/Ctn	Meas	G.W.N.W.
6pcs	78*31*25cm	9/8kg

TG1001019

- 8"Rose Pruner
- 15"Lopping Shear



Qty/Ctn	Meas	G.W.N.W.
12pcs	44*20*46cm	10.5/9.5kg

TG1300002

- 2in1 Dual cut ratchet pruner
- Anvil blade sharpener



Qty/Ctn	Meas	G.W.N.W.
48pcs	57*32*33cm	11.5/10.5kg





MULTIFUNCTIONAL GARDEN PRUNER

BYPASS OR ANVIL TECHNOLOGY?

When purchasing a pruner, it's important to choose the right style depending on what you're cutting

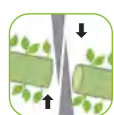

BYPASS

Both blade and counter blade press into the wood to make a clean cut with less compression damage (cutting blade passes counter blade in a scissors-like action). Possible to cut close to the stem. Best suitable for fresh wood.

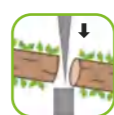

ANVIL

Upper blade is forced through the wood with greater pressure as the anvil blade supports the branch and spreads the pressure until the cut is complete. Best suitable for dry or dead wood.

RATCHET & SINGLE CUT MODE



Ratchet cut
Ratchet mode with 4 short cuts
Cutting capacity: 24mm



Single cut
Single cut mode with 1 effort saving cut
Cutting capacity: 16mm



TG1301014-C

> 8" 2in1 Anvil Ratchet Pruner

- SK5 high carbon steel, non-stick coating blade
- Non-slip & soft handle



Size	Qty/Ctn	Meas	G.W.N.W.
20.5cm	48pcs	32*30*45.5cm	11/10kg



TG1306002

> 8" 2in1 Anvil Ratchet Pruner

- High carbon steel
- Safety lock and Dual-mode switch



Size	Qty/Ctn	Meas	G.W.N.W.
20.5cm	48pcs	44*29*32cm	9/8.4kg

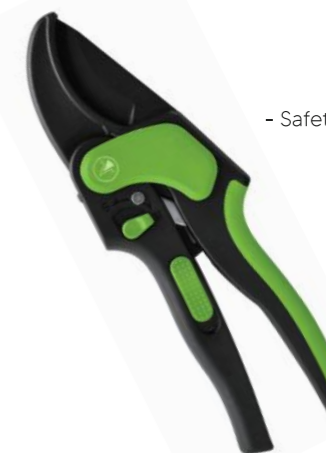

TG1306060

> 8" 2in1 Anvil Ratchet Pruner

- High carbon steel
- Safety lock and Dual-mode switch



Size	Qty/Ctn	Meas	G.W.N.W.
20.5cm	48pcs	44*29*32cm	9/8.4kg



TG1306115-A
 > 8" Bypass Gear Pruner
 - High carbon steel, durable
 - Non-slip handle



Size	Qty/Ctn	Meas	G.W.N.W.
20.5cm	48pcs	38*28*34cm	9/8.4kg



TG1306115-B
 > 8" Anvil Gear Pruner
 - High carbon steel, durable
 - Non-slip handle



Size	Qty/Ctn	Meas	G.W.N.W.
20.5cm	48pcs	38*28*34cm	9.5/8.9kg



TG1301135-A
 > 8" Bypass Gear Pruner
 - High carbon steel, durable



Size	Qty/Ctn	Meas	G.W.N.W.
21cm	48pcs	37*30*29cm	10/9.36kg



TG1301135-B
 > 8" Anvil Gear Pruner
 - High carbon steel, durable



Size	Qty/Ctn	Meas	G.W.N.W.
21cm	48pcs	37*30*29cm	10/9.36kg



TG1306117
 > 8" Anvil Ratchet Pruner
 - High carbon steel, durable



Size	Qty/Ctn	Meas	G.W.N.W.
19.5cm	48pcs	49*27*32cm	6.2/5.7kg



TG1306037
 > 8" Bypass Gear Pruner
 - SK5 high carbon steel, durable
 - Non-slip handle



Size	Qty/Ctn	Meas	G.W.N.W.
22cm	72pcs	45*30.5*47cm	16/15kg



TG1301014-A
 > 8" Ratchet Pruner
 - High carbon steel, durable
 - Non-slip handle



Size	Qty/Ctn	Meas	G.W.N.W.
20cm	48pcs	55*30*24cm	11.5/10.5kg



TG1301120
 > 8" Anvil Ratchet Pruner
 - SK5 high carbon steel, durable
 - Non-slip handle



Size	Qty/Ctn	Meas	G.W.N.W.
20cm	48pcs	55*31*34cm	12/11kg



TG1301113

> 8" Bypass Pruner

- High carbon steel, durable
- Non-slip handle



Size	Qty/Ctn	Meas	G.W.N.W.
20.5cm	48pcs	41.5*39*30cm	12/11kg

TG1301114

> 8" Anvil Pruner

- High carbon steel, durable
- Non-slip handle



Size	Qty/Ctn	Meas	G.W.N.W.
20.5cm	48pcs	41.5*39*30cm	12.5/11.5kg

TG1301117

> 8.5" Floral Snip

- High carbon steel, durable
- Non-slip handle



Size	Qty/Ctn	Meas	G.W.N.W.
22cm	48pcs	41.5*39*30cm	11.5/10.5kg

TG1301111

> 8.5" Adjustable Bypass Pruner

- SK5 high carbon steel, durable
- Non-slip handle



Size	Qty/Ctn	Meas	G.W.N.W.
22cm	48pcs	57*40.5*39cm	14.2/13.2kg

TG1301123-A

> 8" Bypass Pruner

- SK5 high carbon steel, durable
- Non-slip handle



Size	Qty/Ctn	Meas	G.W.N.W.
21cm	24pcs	33*24*32cm	6/5.4kg

TG1301027-B

> 8" Bypass Pruner

- SK5 high carbon steel, durable
- Non-slip handle



Size	Qty/Ctn	Meas	G.W.N.W.
20.5cm	48pcs	41.5*39*30cm	10.5/9.5kg

TG1301112

> 8.5" Adjustable Anvil Pruner

- SK5 high carbon steel, durable
- Non-slip handle



Size	Qty/Ctn	Meas	G.W.N.W.
22cm	48pcs	57*40.5*39cm	14.5/13.5kg

TG1301027-A

> 8" Anvil Pruner

- SK5 high carbon steel, durable
- Non-slip handle



Size	Qty/Ctn	Meas	G.W.N.W.
20.5cm	48pcs	41.5*39*30cm	10.5/9.5kg

TG1301027-C

> 8.5 "Floral Snips

- SK5 high carbon steel, durable
- Non-slip handle



Size	Qty/Ctn	Meas	G.W.N.W.
22cm	48pcs	41.5*39*30cm	10/9kg



TG1301080-A

> 8" Bypass Pruner

- High carbon steel, durable
- Non-slip handle



Size	Qty/Ctn	Meas	G.W.N.W.
20.5cm	60pcs	40*26*20cm	12.4/11.4kg



TG1301128-B

> 8" Bypass Pruner

- SK5 high carbon steel, durable
- Non-slip handle



Size	Qty/Ctn	Meas	G.W.N.W.
20.5cm	48pcs	41.5*39*30cm	13/12kg



TG1301001

> 8" Bypass Pruner

- SK5 high carbon steel, durable
- Non-slip handle



Size	Qty/Ctn	Meas	G.W.N.W.
20.5cm	48pcs	41.5*39*30cm	10.2/9.6kg



TG1301106-C

> 8.5" Bypass Pruner

- SK5 high carbon steel, durable
- Non-slip handle



Size	Qty/Ctn	Meas	G.W.N.W.
22cm	60pcs	56.7*30.6*31.9cm	18.4/17.4kg

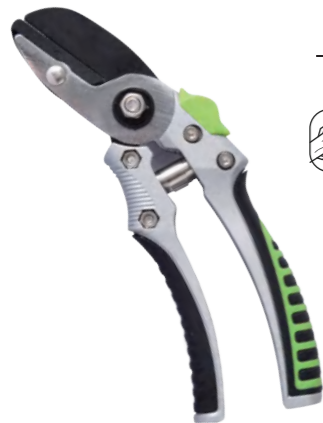

TG1301080-C

> 8" Anvil Pruner

- High carbon steel, durable
- Non-slip handle



Size	Qty/Ctn	Meas	G.W.N.W.
20.5cm	60pcs	40*26*20cm	12/11kg



TG1301025

> 8" Bypass Pruner

- SK5 high carbon steel, durable
- Non-slip handle



Size	Qty/Ctn	Meas	G.W.N.W.
21cm	60pcs	83.5*27*26cm	15.4/14.4kg



TG1301132

> 8" Cut And Hold Pruner

- High carbon steel, durable
- Non-slip handle



Size	Qty/Ctn	Meas	G.W.N.W.
21.5cm	48pcs	42*21*24cm	12.5/11.5kg



TG1301072

> 8" Anvil Pruner

- High carbon steel, durable
- Non-slip handle



Size	Qty/Ctn	Meas	G.W.N.W.
20.5cm	48pcs	38*29.5*34.5cm	12/11kg



TG1301080-B

> 8" Floral Snips

- High carbon steel, durable
- Non-slip handle



Size	Qty/Ctn	Meas	G.W.N.W.
20.5cm	60pcs	40*26*20cm	11/10kg



TG1301025-B

> 8" Anvil Pruner

- SK5 high carbon steel, durable
- Non-slip handle



Size	Qty/Ctn	Meas	G.W.N.W.
21cm	60pcs	83.5*27*26cm	15.7/14.7kg



TG1301072-A

> 8" Bypass Pruner

- High carbon steel, durable
- Non-slip handle



Size	Qty/Ctn	Meas	G.W.N.W.
21cm	48pcs	38*29.5*34.5cm	12/11kg



TG1301127

> 8" Bypass Pruner

- High carbon steel, durable
- Non-slip handle



Size	Qty/Ctn	Meas	G.W.N.W.
21cm	48pcs	42*21*24cm	9.6/8.64kg



TG1301062-C

> 8" Bypass Pruner
- Stainless steel
- Aluminium handle



Size	Qty/Ctn	Meas	G.W.N.W.
20.5cm	60pcs	54*29*32cm	15.4/14.4kg



TG1301049-B

> 8" Bypass Pruner
- Stainless steel
- Aluminium handle



Size	Qty/Ctn	Meas	G.W.N.W.
20.5cm	48pcs	40*29*32cm	12/11kg



TG1301058

> 8.5" Aluminium Forged Pruner
- SK5 high carbon steel, durable
- Non-slip handle



Size	Qty/Ctn	Meas	G.W.N.W.
22cm	60pcs	50*29*29cm	17/16kg



TG1301021

> 8" Steel Forged Bypass Pruner
- High carbon steel, durable
- Non-slip handle



Size	Qty/Ctn	Meas	G.W.N.W.
21cm	50pcs	58*22*28cm	15.2/14.2kg



TG1301093

> 7" Bypass Pruner
- Stainless steel
- Non-slip handle



Size	Qty/Ctn	Meas	G.W.N.W.
18cm	48pcs	29*35*25cm	7.5/6.5kg



TG1301090

> 8" Anvil Pruner
- High carbon steel, durable
- Non-slip handle



Size	Qty/Ctn	Meas	G.W.N.W.
20.5cm	48pcs	35*25*30cm	13/12kg



TG1301021-A

> 8" Steel Forged Floral Snips
- High carbon steel, durable
- Non-slip handle



Size	Qty/Ctn	Meas	G.W.N.W.
20cm	60pcs	50*29*29cm	15/13kg



TG1402008

> 12" Steel Forged Grass Shear
- High carbon steel, durable
- Non-slip handle



Size	Qty/Ctn	Meas	G.W.N.W.
31cm	24pcs	33*20*22cm	11.5/10.5kg



TG1301029

> 8.5" Heavy Duty Bypass Pruner
- High carbon steel, durable
- Non-slip handle



Size	Qty/Ctn	Meas	G.W.N.W.
22cm	60pcs	47*33*28cm	16/15kg

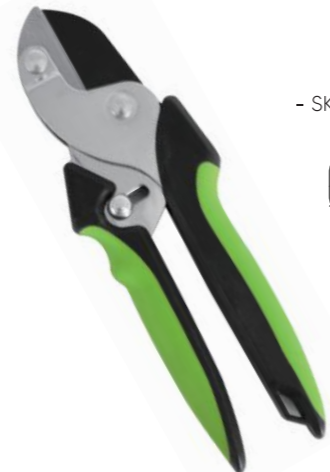

TG1306083

> 8" Anvil Pruner
- SK5 high carbon steel, durable
- Non-slip handle



Size	Qty/Ctn	Meas	G.W.N.W.
21cm	48pcs	51*29*29cm	14.5/13.5kg



TG1301017-8"-A

> 8" Steel Forged Bypass Pruner
- High carbon steel, durable
- Non-slip handle



Size	Qty/Ctn	Meas	G.W.N.W.
20.5cm	48pcs	46*27*22cm	15.4/14.4kg



TG1301017-8"-B

> 8" Steel Forged Grass Shear
- SK5 high carbon steel, durable
- Non-slip handle



Size	Qty/Ctn	Meas	G.W.N.W.
20.5cm	48pcs	46*27*22cm	13.5/12.5kg



TG1306087

> 8.5" Adjustable Anvil Pruner
- High carbon steel, durable
- Non-slip handle



Size	Qty/Ctn	Meas	G.W.N.W.
21.5cm	48pcs	41.5*39*30cm	11.5/10.5kg



TG1306088

> 8.5" Adjustable Bypass Pruner
- High carbon steel, durable
- Non-slip handle



Size	Qty/Ctn	Meas	G.W.N.W.
22cm	48pcs	41.5*39*30cm	11.5/10.5kg



TG1306113-B

> 8" Adjustable Anvil Pruner
- High carbon steel, durable
- Non-slip handle



Size	Qty/Ctn	Meas	G.W.N.W.
20cm	48pcs	39*29*31cm	12.3/11.3kg



TG1306113-A

> 8" Adjustable Bypass Pruner
- High carbon steel, durable
- Non-slip handle



Size	Qty/Ctn	Meas	G.W.N.W.
20.5cm	48pcs	39*29*31cm	12.3/11.3kg



TG1306048-A

> 8" Adjustable Anvil Pruner
- High carbon steel, durable
- Non-slip handle



Size	Qty/Ctn	Meas	G.W.N.W.
20.5cm	60pcs	38*29*40.5cm	14/13kg



TG1306048-B

> 8" Adjustable Bypass Pruner
- High carbon steel, durable
- Non-slip handle



Size	Qty/Ctn	Meas	G.W.N.W.
20.5cm	60pcs	38*29*40.5cm	14/13kg

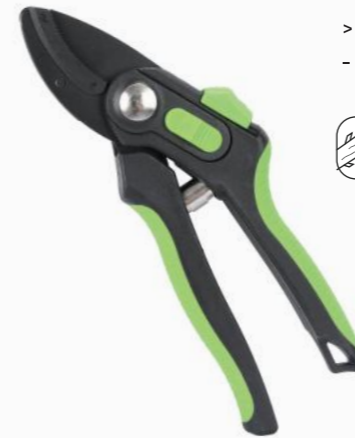

TG1306049-B

> 8" Adjustable Anvil Pruner
- High carbon steel, durable
- Non-slip handle



Size	Qty/Ctn	Meas	G.W.N.W.
21cm	48pcs	28*23*32cm	11/10kg



TG1306049-A

> 8" Adjustable Bypass Pruner
- High carbon steel, durable
- Non-slip handle



Size	Qty/Ctn	Meas	G.W.N.W.
21cm	48pcs	28*23*32cm	11/10kg



TG1306074-B

> 8.5" Adjustable Anvil Pruner
- High carbon steel, durable
- Non-slip handle



Size	Qty/Ctn	Meas	G.W.N.W.
21.5cm	72pcs	56.7*30.6*31.9cm	16.5/15.2kg



TG1306074-A

> 8.5" Adjustable Bypass Pruner
- High carbon steel, durable
- Non-slip handle



Size	Qty/Ctn	Meas	G.W.N.W.
21.5cm	72pcs	56.7*30.6*31.9cm	16/14.4kg



TG1306125-B

> 8" Adjustable Anvil Pruner
- High carbon steel, durable
- Non-slip handle



Size	Qty/Ctn	Meas	G.W.N.W.
20.5cm	48pcs	44*28*32cm	10/9kg

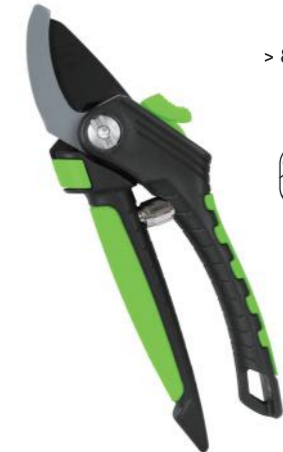

TG1306125-A

> 8" Adjustable Bypass Pruner
- High carbon steel, durable
- Non-slip handle



Size	Qty/Ctn	Meas	G.W.N.W.
20.5cm	48pcs	44*28*32cm	10/9kg



TG1306085

> 8" Anvil Pruner

- High carbon steel, durable
- Non-slip handle



Size	Qty/Ctn	Meas	G.W.N.W.
20.5cm	48pcs	41.5*39*30cm	9/8.3kg



TG1306124-B

> 8" Bypass Pruner

- SK5 high carbon steel, durable
- Non-slip handle



Size	Qty/Ctn	Meas	G.W.N.W.
21cm	72pcs	58*29*33.5cm	16.5/15.5kg



TG1306123-A

> 8" Anvil Pruner

- SK5 high carbon steel, durable
- Non-slip handle



Size	Qty/Ctn	Meas	G.W.N.W.
21cm	72pcs	58*29*33.5cm	16.5/15.5kg



TG1306198-A

> 8.5" Bypass Pruner

- High carbon steel, durable
- Non-slip handle



Size	Qty/Ctn	Meas	G.W.N.W.
21.5cm	72pcs	58*29*29.5cm	16.5/15.5kg



TG1306093

> 8.5" Floral Snips

- High carbon steel, durable
- Non-slip handle



Size	Qty/Ctn	Meas	G.W.N.W.
22cm	48pcs	41.5*39*30cm	9/8.2kg



TG1306124-A

> 8" Anvil Pruner

- SK5 high carbon steel, durable
- Non-slip handle



Size	Qty/Ctn	Meas	G.W.N.W.
21cm	72pcs	58*29*33.5cm	16.5/15.5kg



TG1306123-B

> 8" Bypass Pruner

- SK5 high carbon steel, durable
- Non-slip handle



Size	Qty/Ctn	Meas	G.W.N.W.
21cm	72pcs	58*29*33.5cm	16.5/15.5kg



TG1306198-B

> 8.5" Anvil Pruner

- High carbon steel, durable
- Non-slip handle



Size	Qty/Ctn	Meas	G.W.N.W.
21.5cm	72pcs	58*29*29.5cm	17/16kg



TG1306086

> 8" Bypass Pruner

- High carbon steel, durable
- Non-slip handle



Size	Qty/Ctn	Meas	G.W.N.W.
20.5cm	48pcs	41.5*39*30cm	9/8.2kg



TG1306124-C

> 8" Floral Snips

- SK5 high carbon steel, durable
- Non-slip handle



Size	Qty/Ctn	Meas	G.W.N.W.
21cm	72pcs	58*29*33.5cm	16.2/15.2kg



TG1306123-C

> 8" Floral Snips

- SK5 high carbon steel, durable
- Non-slip handle



Size	Qty/Ctn	Meas	G.W.N.W.
21cm	72pcs	58*29*33.5cm	16.2/15.2kg



TG1306198-C

> 8" Floral Snips

- High carbon steel, durable
- Non-slip handle



Size	Qty/Ctn	Meas	G.W.N.W.
21cm	72pcs	58*29*33.5cm	16/15kg



TG1306059-A

> 7" Anvil Pruner
- High carbon steel, durable
- Non-slip handle



Size	Qty/Ctn	Meas	G.W.N.W.
18cm	72pcs	59*29.5*32.5cm	13/12kg



TG1306128-B

> 8" Anvil Pruner
- High carbon steel, durable
- Non-slip handle



Size	Qty/Ctn	Meas	G.W.N.W.
21cm	48pcs	39*29*31cm	9.5/9.1kg



TG1306012-A

> 8" Bypass Pruner
- High carbon steel, durable
- Non-slip handle



Size	Qty/Ctn	Meas	G.W.N.W.
20.5cm	60pcs	50*27*23cm	13/12kg



TG1306012-B

> 8" Anvil Pruner
- High carbon steel, durable
- Non-slip handle



Size	Qty/Ctn	Meas	G.W.N.W.
20.5cm	60pcs	50*27*23cm	13.4/12.4kg



TG1306059-C

> 7" Bypass Pruner
- High carbon steel, durable
- Non-slip handle



Size	Qty/Ctn	Meas	G.W.N.W.
18cm	72pcs	59*29.5*32.5cm	13/12kg



TG1306128-A

> 8" Bypass Pruner
- High carbon steel, durable
- Non-slip handle



Size	Qty/Ctn	Meas	G.W.N.W.
21cm	48pcs	39*29*31cm	9/8.35kg



TG1306127-A

> 7.5" Bypass Pruner
- High carbon steel, durable
- Non-slip handle



Size	Qty/Ctn	Meas	G.W.N.W.
19cm	72pcs	32*24*26cm	9/8.3kg



TG1306127-B

> 7.5" Floral Snips
- High carbon steel, durable
- Non-slip handle



Size	Qty/Ctn	Meas	G.W.N.W.
19.5cm	72pcs	32*24*26cm	8/7.56kg



TG1306059-B

> 7.5" Floral Snips
- High carbon steel, durable
- Non-slip handle



Size	Qty/Ctn	Meas	G.W.N.W.
19.5cm	72pcs	59*29.5*32.5cm	12/11kg

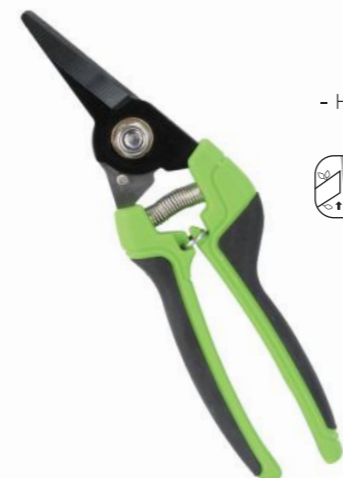

TG1306128-C

> 8.5" Floral Snips
- High carbon steel, durable
- Non-slip handle



Size	Qty/Ctn	Meas	G.W.N.W.
21.5cm	48pcs	39*29*31cm	9/8.35kg



TG1306103

> 7.5" Bypass Pruner
- High carbon steel, durable
- Non-slip handle



Size	Qty/Ctn	Meas	G.W.N.W.
19cm	48pcs	39*29*31cm	9.5/8.5kg



TG1306055

> 7" Bypass Pruner
- High carbon steel, durable
- Non-slip handle



Size	Qty/Ctn	Meas	G.W.N.W.
17.5cm	60pcs	42*26*23cm	9.5/8.7kg



TG1301144-A

> 6" Pruning Shears

- SK5 high carbon steel, durable
- Non-slip handle



Size	Qty/Ctn	Meas	G.W.N.W.
16cm	72pcs	40.5*23.5*29cm	7.5/7kg



TG1301144-B

> 6" Floral Snips

- SK5 high carbon steel, durable
- Non-slip handle



Size	Qty/Ctn	Meas	G.W.N.W.
16.5cm	72pcs	40.5*23.5*29cm	6.5/6kg



TG1301002-B

> 6" Pruning Shears

- SK5 high carbon steel, durable
- Non-slip handle



Size	Qty/Ctn	Meas	G.W.N.W.
16.5cm	72pcs	40.5*23.5*29cm	10.5/9.5kg



TG1301002-A

> 6" Floral Snips

- SK5 high carbon steel, durable
- Non-slip handle



Size	Qty/Ctn	Meas	G.W.N.W.
16.5cm	72pcs	40.5*23.5*29cm	10.5/9.5kg



TG1301124-A

> 6" Pruning Shears

- SK5 high carbon steel, durable
- Non-slip handle



Size	Qty/Ctn	Meas	G.W.N.W.
15.5cm	72pcs	40.5*23.5*29cm	5/4.3kg



TG1301124-B

> 6" Floral Snips

- SK5 high carbon steel, durable
- Non-slip handle



Size	Qty/Ctn	Meas	G.W.N.W.
15.5cm	72pcs	40.5*23.5*29cm	4/3.6kg



TG1306129-A

> 8" Bypass Pruner

- High carbon steel, durable
- Non-slip handle



Size	Qty/Ctn	Meas	G.W.N.W.
20.5cm	48pcs	41.5*39*30cm	9.2/8.64kg



TG1306129-B

> 8" Anvil Pruner

- High carbon steel, durable
- Non-slip handle



Size	Qty/Ctn	Meas	G.W.N.W.
20.5cm	48pcs	41.5*39*30cm	9.2/8.64kg



TG1301102

> Garden Scissors

- High carbon steel, durable
- Non-slip handle



Size	Qty/Ctn	Meas	G.W.N.W.
15.5cm	24pcs	22*12*20cm	2.85/2.55kg



TG1301102-A

> Garden Scissors

- High carbon steel, durable
- Non-slip handle



Size	Qty/Ctn	Meas	G.W.N.W.
16cm	24pcs	22*12*20cm	2.85/2.55kg



TG1306089

- > 8" Garden scissors
- High carbon steel, durable
- Non-slip handle



Size	Qty/Ctn	Meas	G.W.N.W.
20.5cm	48pcs	47*29*24cm	7/6kg

TG1306047

- > 7.5" Garden scissors
- Stainless steel
- Non-slip handle



Size	Qty/Ctn	Meas	G.W.N.W.
19cm	72pcs	45*26*30cm	7.5/6.5kg

TG1301011

- > 7" Bonsai scissors
- High carbon steel, durable
- Non-slip handle



Size	Qty/Ctn	Meas	G.W.N.W.
18cm	60pcs	68*37*32cm	13/12kg

TG1301012

- > 8" Bonsai scissors
- High carbon steel, durable
- Non-slip handle



Size	Qty/Ctn	Meas	G.W.N.W.
20cm	60pcs	68*27*32cm	12.5/11.5kg

TG1306080

- > 6.5" Garden scissors
- Stainless steel
- Non-slip handle



Size	Qty/Ctn	Meas	G.W.N.W.
17cm	72pcs	52.5*25.5*39cm	9/7.2kg

TG1306028

- > 10" Garden scissors
- High carbon steel, durable
- Non-slip handle



Size	Qty/Ctn	Meas	G.W.N.W.
25.5cm	48pcs	48*32*18cm	9/8kg

TG1402003

- > Wool Shears
- SK5 high carbon steel, durable
- Non-slip handle



Size	Qty/Ctn	Meas	G.W.N.W.
33cm	36pcs	34*31*40cm	14.3/13.3kg

TG1402004

- > Wool Shears
- SK5 high carbon steel, durable
- Non-slip handle



Size	Qty/Ctn	Meas	G.W.N.W.
33cm	36pcs	34*31*40cm	15.5/14.5kg

GRASS SHEARS

Grass shears differ from pruning shears in being long-handled and having the handles at right-angles to the blades.



TG1401022
 > 360° Grass Shear
 - 360° rotation
 - High carbon steel



Size	Qty/Ctn	Meas	G.W.N.W.
33cm	24pcs	49*41*20cm	7/6.2kg

TG1401020
 > 180° Long Handle Grass Shear
 - Rotatable 180-degree blades
 - High carbon steel



Size	Qty/Ctn	Meas	G.W.N.W.
128cm	12pcs	135*47*18cm	10.5/9kg

TG1401016
 > 360° Grass Shear
 - 360° rotation
 - High carbon steel



Size	Qty/Ctn	Meas	G.W.N.W.
35.5cm	36pcs	42*35*36cm	10.6/9.6kg

TG1401006
 > 360° Grass Shear
 - 360° rotation
 - High carbon steel



Size	Qty/Ctn	Meas	G.W.N.W.
36cm	24pcs	49*41*20cm	8/7kg

TG1401017
 > 90° Grass Shear
 - 90° rotation
 - High carbon steel



Size	Qty/Ctn	Meas	G.W.N.W.
33.5cm	24pcs	39.5*21*25.5cm	10/9kg

TG1401012
 > 360° Grass Shear
 - 360° rotation
 - High carbon steel

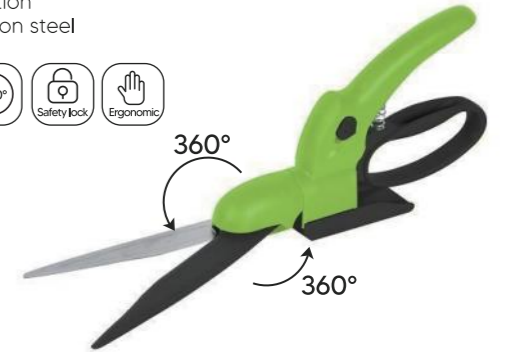

Size	Qty/Ctn	Meas	G.W.N.W.
35cm	24pcs	46*43*23cm	8.6/7.6kg

TG1401004-H
 > 180° Grass Shear
 - 180° rotation
 - High carbon steel



Size	Qty/Ctn	Meas	G.W.N.W.
34cm	24pcs	46*40*21cm	7/6kg

TG1402001
 > Grass Shear
 - Lightweight for easy handling
 - High carbon steel



Size	Qty/Ctn	Meas	G.W.N.W.
33cm	24pcs	33*32*17cm	4.93/4.4kg



FOLDING SAW

Allows for efficient cutting during camping, survival, jungle landscaping and general yard work

10" EXTRA LONG BLADE

For cutting 7-8 inch diameter branches

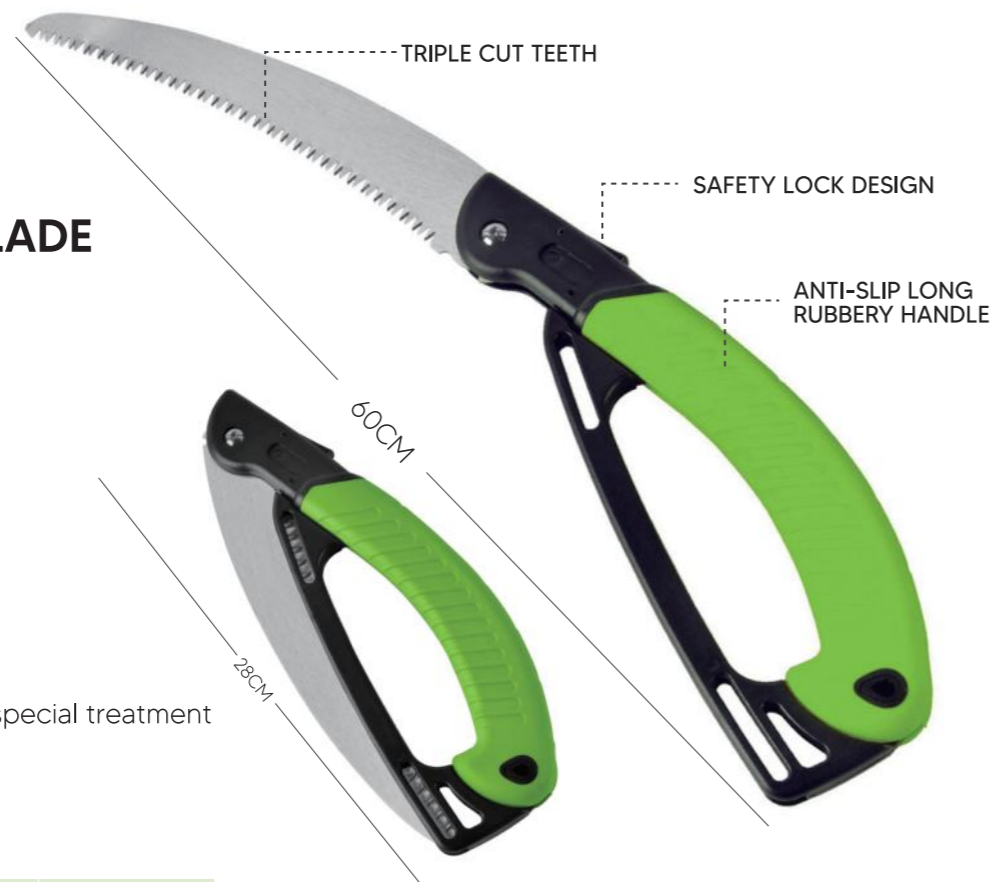

TG1501013

- > Foldable Saw
- High quality Steel blades with special treatment
- Teeth: three side sharpened

Size	Qty/Ctn	Meas	G.W.N.W.
28-60cm	36pcs	56*35*28cm	15/14kg

TG1501027

- > Folding Saw
- High quality steel
- Non-slip handle

Size	Qty/Ctn	Meas	G.W.N.W.
25-52.5cm	72pcs	64*39*36cm	24.3/23.3kg

TG1501028

- > Folding Saw
- High quality steel
- Non-slip handle

Size	Qty/Ctn	Meas	G.W.N.W.
25-52.5cm	72pcs	64*39*36cm	26/25kg

TG1501026

- > Folding Saw
- SK5 High quality steel
- Non-slip handle

Size	Qty/Ctn	Meas	G.W.N.W.
23-44cm	72pcs	54*35.5*32cm	17.5/16.2kg

TG1501031

- > Folding Saw
- High quality steel
- Non-slip handle

Size	Qty/Ctn	Meas	G.W.N.W.
24-46.5cm	48pcs	35*36*33cm	14.5/13.5kg

TG1501024

- > Folding Saw
- High quality steel
- Non-slip handle

Size	Qty/Ctn	Meas	G.W.N.W.
25-46.5cm	48pcs	43*36*36cm	14/13kg

TG1501007

- > Folding Saw
- Two cutting angles: 180°/140°
- High quality steel
- Non-slip handle

Size	Qty/Ctn	Meas	G.W.N.W.
23.3cm	48pcs	32*24*43cm	7.2/6.25kg

TG1502001

> Pruning Saw

- High quality Steel blade
- Non-slip handle



Size	Qty/Ctn	Meas	G.W.N.W.
30cm	36pcs	52*26*45cm	18/17kg

TG1507005

> Pruning Saw

- High quality Steel blade
- Non-slip handle



Size	Qty/Ctn	Meas	G.W.N.W.
33cm	36pcs	56*35*28cm	15/14kg

TG1700003/HEAD

> Pruning Saw

- High quality Steel blade
- Non-slip handle



Size	Qty/Ctn	Meas	G.W.N.W.
52cm	48pcs	42*24*30cm	19/18kg

TG1507006

> Pruning saw

- High quality Steel blade
- Wooden handle



Size	Qty/Ctn	Meas	G.W.N.W.
47.5cm	36pcs	56*35*28cm	15/14kg

TG1505002-21

> 21" Bow Saw

- Hardened carbon steel blade with rust inhibitor
- Safety tension lever for added control



Size	Qty/Ctn	Meas	G.W.N.W.
53.5cm	18pcs	65.5*40*23cm	9/8kg

TG1505024

> 21" Bow Saw

- Hardened carbon steel blade with rust inhibitor
- Safety tension lever for added control



Size	Qty/Ctn	Meas	G.W.N.W.
53.5cm	6pcs	63*22.5*15.5cm	4.5/3.48kg

TG1503015

> Telesopic Tree Pruner

- Sk5 high quality steel blades
- Adjustable height



Size	Qty/Ctn	Meas	G.W.N.W.
136-200cm	6pcs	120*23.5*12cm	9/8.38kg

TG1503004

> Telesopic Tree Pruner

- High carbon steel, durable
- Adjustable height



Size	Qty/Ctn	Meas	G.W.N.W.
170-290cm	6pcs	170*12*24cm	8.5/7kg

TG1503012

> Telesopic Tree Pruner

- High carbon steel, durable
- Adjustable height



Size	Qty/Ctn	Meas	G.W.N.W.
137-149cm	12pcs	126*36*19cm	17/14.5kg

TG1503002

> Telesopic Tree Pruner

- High carbon steel, durable
- Adjustable height



Size	Qty/Ctn	Meas	G.W.N.W.
172-280cm	6pcs	164*23.5*11.5cm	11/10kg